

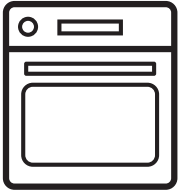

**Electrolux**



[electrolux.com/register](https://electrolux.com/register)



EN User Manual | **Oven**

**KOEBP39X**

**KOEBP39Z**



# Welcome to Electrolux! Thank you for choosing our appliance.



Get usage advice, brochures, trouble shooter, service and repair information:  
[www.electrolux.com/support](http://www.electrolux.com/support)

Subject to change without notice.

## CONTENTS

1. SAFETY INFORMATION.....	2
2. SAFETY INSTRUCTIONS.....	4
3. PRODUCT DESCRIPTION.....	7
4. CONTROL PANEL.....	8
5. BEFORE FIRST USE.....	9
6. DAILY USE.....	10
7. CLOCK FUNCTIONS.....	13
8. USING THE ACCESSORIES.....	15
9. ADDITIONAL FUNCTIONS.....	17
10. HINTS AND TIPS.....	18
11. CARE AND CLEANING.....	20
12. TROUBLESHOOTING.....	24
13. ENERGY EFFICIENCY.....	25
14. MENU STRUCTURE.....	26
15. IT'S EASY!.....	28
16. ENVIRONMENTAL CONCERNS.....	28

## 1. ⚠ SAFETY INFORMATION

Before the installation and use of the appliance, carefully read the supplied instructions. The manufacturer is not responsible for any injuries or damage that are the result of incorrect installation or usage. Always keep the instructions in a safe and accessible location for future reference.

### 1.1 Children and vulnerable people safety

- This appliance can be used by children aged from 8 years and above and persons with reduced physical, sensory or mental capabilities or lack of experience and knowledge if they have been given supervision or instruction concerning the use of the appliance in a safe way and understand the hazards involved. Children of less than 8 years of age and persons with very extensive and complex disabilities shall

be kept away from the appliance unless continuously supervised.

- Children should be supervised to ensure that they do not play with the appliance.
- Keep all packaging away from children and dispose of it appropriately.
- **WARNING:** The appliance and its accessible parts become hot during use. Keep children and pets away from the appliance when in use and when cooling down.
- If the appliance has a child safety device, it should be activated.
- Children shall not carry out cleaning and user maintenance of the appliance without supervision.

## **1.2 General Safety**

- This appliance is for cooking purposes only.
- This appliance is designed for single household domestic use in an indoor environment.
- This appliance may be used in, offices, hotel guest rooms, bed & breakfast guest rooms, farm guest houses and other similar accommodation where such use does not exceed (average) domestic usage levels.
- Only a qualified person must install this appliance and replace the cable.
- Do not use the appliance before installing it in the built-in structure.
- Disconnect the appliance from the power supply before carrying out any maintenance.
- If the supply cord is damaged, it must be replaced by the manufacturer, its Authorised Service Centre or similarly qualified persons to avoid an electrical hazard.
- **WARNING:** Ensure that the appliance is switched off before replacing the lamp to avoid the possibility of electric shock.
- **WARNING:** The appliance and its accessible parts become hot during use. Care should be taken to avoid touching heating elements or the surface of the appliance cavity.

- Always use oven gloves to remove or insert accessories or ovenware.
- Use only the food sensor (core temperature sensor) recommended for this appliance.
- To remove the shelf supports first pull the front of the shelf support and then the rear end away from the side walls. Install the shelf supports in the opposite sequence.
- Do not use a steam cleaner to clean the appliance.
- Do not use harsh abrasive cleaners or sharp metal scrapers to clean the glass door since they can scratch the surface, which may result in shattering of the glass.
- Before pyrolytic cleaning, remove all accessories and excessive deposits/spills from the appliance cavity.

## 2. SAFETY INSTRUCTIONS

### 2.1 Installation

#### **WARNING!**

Only a qualified person must install this appliance.

- Remove all the packaging.
- Do not install or use a damaged appliance.
- Follow the installation instructions supplied with the appliance.
- Always take care when moving the appliance as it is heavy. Always use safety gloves and enclosed footwear.
- Do not pull the appliance by the handle.
- Install the appliance in a safe and suitable place that meets installation requirements.
- Keep the minimum distance from other appliances and units.
- Before mounting the appliance, check if the appliance door opens without restraint.
- The appliance is equipped with an electric cooling system. It must be operated with the electric power supply.
- The built-in unit must meet the stability requirements of DIN 68930.

Cabinet minimum height (Cabinet under the worktop minimum height)	578 (600) mm
---	--------------

Cabinet width	560 mm
Cabinet depth	550 (550) mm
Height of the front of the appliance	594 mm
Height of the back of the appliance	576 mm
Width of the front of the appliance	595 mm
Width of the back of the appliance	559 mm
Depth of the appliance	567 mm
Built in depth of the appliance	546 mm
Depth with open door	1027 mm
Ventilation opening minimum size. Opening placed on the bottom rear side	560x20 mm
Mains supply cable length. Cable is placed in the right corner of the back side	1500 mm
Mounting screws	4x25 mm

## 2.2 Electrical connection

### **WARNING!**

Risk of fire and electric shock.

- All electrical connections should be made by a qualified electrician.
- The appliance must be earthed.
- Make sure that the parameters on the rating plate are compatible with the electrical ratings of the mains power supply.
- Always use a correctly installed shockproof socket.
- Do not use multi-plug adapters and extension cables.
- Make sure not to cause damage to the mains plug and to the mains cable. Should the mains cable need to be replaced, this must be carried out by our Authorised Service Centre.
- Do not let mains cables touch or come near the appliance door or the niche below the appliance, especially when it operates or the door is hot.
- The shock protection of live and insulated parts must be fastened in such a way that it cannot be removed without tools.
- Connect the mains plug to the mains socket only at the end of the installation. Make sure that there is access to the mains plug after the installation.
- If the mains socket is loose, do not connect the mains plug.
- Do not pull the mains cable to disconnect the appliance. Always pull the mains plug.
- Use only correct isolation devices: line protecting cut-outs, fuses (screw type fuses removed from the holder), earth leakage trips and contactors.
- The electrical installation must have an isolation device which lets you disconnect the appliance from the mains at all poles. The isolation device must have a contact opening width of minimum 3 mm.
- Fully close the appliance door before you connect the mains plug to the mains socket.
- This appliance is supplied with a main plug and a main cable.

## 2.3 Use

### **WARNING!**

Risk of injury, burns and electric shock or explosion.

- Do not change the specification of this appliance.
- Make sure that the ventilation openings are not blocked.
- Do not let the appliance stay unattended during operation.
- Deactivate the appliance after each use.
- Be careful when you open the appliance door while the appliance is in operation. Hot air can release.
- Do not operate the appliance with wet hands or when it has contact with water.
- Do not apply pressure on the open door.
- Do not use the appliance as a work surface or as a storage surface.
- Open the appliance door carefully. The use of ingredients with alcohol can cause a mixture of alcohol and air.
- Do not let sparks or open flames to come in contact with the appliance when you open the door.
- Do not put flammable products or items that are wet with flammable products in, near or on the appliance.

### **WARNING!**

Risk of damage to the appliance.

- To prevent damage or discoloration to the enamel:
  - do not put ovenware or other objects in the appliance directly on the bottom.
  - do not put aluminium foil directly on the bottom of cavity of the appliance.
  - do not put water directly into the hot appliance.
  - do not keep moist dishes and food in the appliance after you finish the cooking.
  - be careful when you remove or install the accessories.
- Discoloration of the enamel or stainless steel has no effect on the performance of the appliance.
- Use a deep pan for moist cakes. Fruit juices cause stains that can be permanent.

- Always cook with the appliance door closed.
- If the appliance is installed behind a furniture panel (e.g. a door) make sure the door is never closed when the appliance operates. Heat and moisture can build up behind a closed furniture panel and cause subsequent damage to the appliance, the housing unit or the floor. Do not close the furniture panel until the appliance has cooled down completely after use.

## 2.4 Care and cleaning

### **WARNING!**

Risk of injury, fire, or damage to the appliance.

- Before maintenance, deactivate the appliance and disconnect the mains plug from the mains socket.
- Make sure the appliance is cold. There is the risk that the glass panels can break.
- Replace immediately the door glass panels when they are damaged. Contact the Authorised Service Centre.
- Be careful when you remove the door from the appliance. The door is heavy!
- Clean regularly the appliance to prevent the deterioration of the surface material.
- Clean the appliance with a moist soft cloth. Use only neutral detergents. Do not use abrasive products, abrasive cleaning pads, solvents or metal objects.
- If you use an oven spray, follow the safety instructions on its packaging.

## 2.5 Pyrolytic cleaning

### **WARNING!**

Risk of Injury / Fires / Chemical Emissions (Fumes) in Pyrolytic Mode.

- Before carrying out the pyrolytic cleaning and initial preheating remove from the oven cavity:
  - any excess food residues, oil or grease spills / deposits.
  - any removable objects (including shelves, side rails, etc., provided with the appliance) especially any non-stick pots, pans, trays, utensils, etc.

- Read carefully all the instructions for pyrolytic cleaning.
- Keep children away from the appliance while the pyrolytic cleaning operates. The appliance becomes very hot and hot air is released from the front cooling vents.
- Pyrolytic cleaning is a high temperature operation that can release fumes from cooking residues and construction materials, as such consumers are advised to:
  - provide good ventilation during and after the pyrolytic cleaning.
  - provide good ventilation during and after the initial preheating.
- Do not spill or apply water on the oven door during and after the pyrolytic cleaning to avoid damaging the glass panels.
- Fumes released from all pyrolytic ovens / cooking residues as described are not harmful to humans, including children, or persons with medical conditions.
- Keep pets away from the appliance during and after the pyrolytic cleaning and initial preheating. Small pets (especially birds and reptiles) can be highly sensitive to temperature changes and emitted fumes.
- Non-stick surfaces on pots, pans, trays, utensils etc., can be damaged by the high temperature pyrolytic cleaning operation of all pyrolytic ovens and can be also a source for low level harmful fumes.

## 2.6 Internal lighting

### **WARNING!**

Risk of electric shock.

- Concerning the lamp(s) inside this product and spare part lamps sold separately: These lamps are intended to withstand extreme physical conditions in household appliances, such as temperature, vibration, humidity, or are intended to signal information about the operational status of the appliance. They are not intended to be used in other applications and are not suitable for household room illumination.
- This product contains a light source of energy efficiency class G.
- Use only lamps with the same specifications.

## 2.7 Service

- To repair the appliance contact the Authorised Service Centre.
- Use original spare parts only.

## 2.8 Disposal

### **WARNING!**

Risk of injury or suffocation.

- Contact your municipal authority for information on how to dispose of the appliance.
- Disconnect the appliance from the mains supply.
- Cut off the mains electrical cable close to the appliance and dispose of it.
- Remove the door catch to prevent children or pets from becoming trapped in the appliance.

## 3. PRODUCT DESCRIPTION

### 3.1 General overview

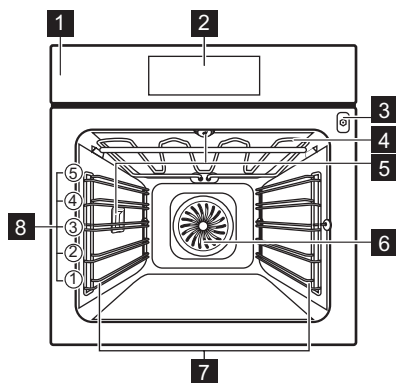

- 1** Control panel
- 2** Display
- 3** Socket for the food sensor
- 4** Heating element
- 5** Lamp
- 6** Fan
- 7** Shelf support, removable
- 8** Shelf positions

### 3.2 Accessories

#### Wire shelf

For cookware, cake tins, roasts.

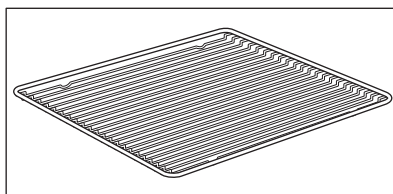

#### Baking tray

For cakes and biscuits.

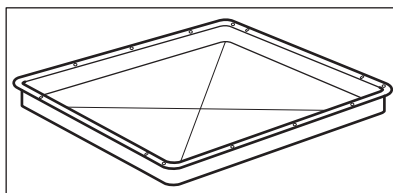

### Grill- / Roasting pan

To bake and roast or as a pan to collect fat.

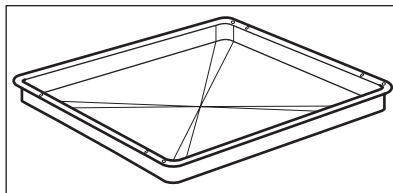

### Food Sensor

To measure the temperature inside food.

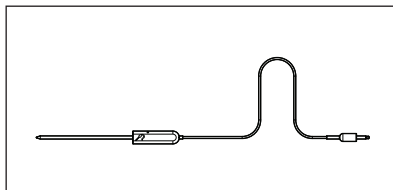

### Telescopic runners

For inserting and removing trays and wireshelf more easily.

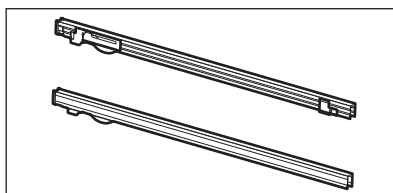

## 4. CONTROL PANEL

### 4.1 Control panel overview

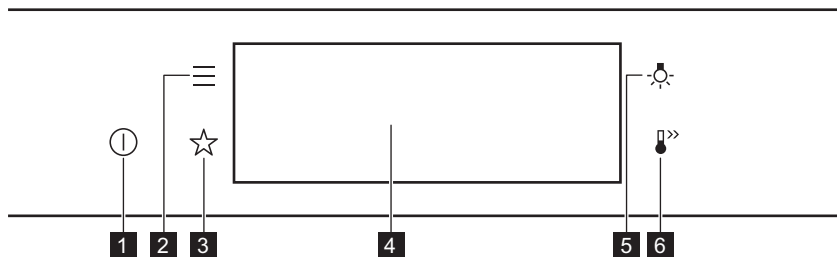

<b>1</b>	ON / OFF	Press and hold to turn the appliance on and off.
<b>2</b>	Menu	Lists the appliance functions.
<b>3</b>	Favourites	Lists the favourite settings.
<b>4</b>	Display	Shows the current settings of the appliance.
<b>5</b>	Lamp switch	To turn the lamp on and off.
<b>6</b>	Fast Heat Up	To turn on and off the function: Fast Heat Up.





Press

Touch the surface with fingertip.



Move

Slide fingertip over the surface.



Press and hold

Touch the surface for 3 seconds.

## 4.2 Display

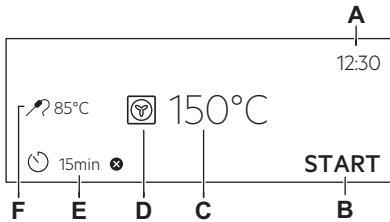

Display with key functions set.

- A. Time of Day
- B. START/STOP
- C. Temperature
- D. Heating functions
- E. Timer
- F. Food Sensor (selected models only)

### Display indicators

**Basic indicators** - to navigate on the display.



To confirm the selection / setting.



To go one level back in the menu.



To undo the last action.



To turn the options on and off.

**Sound Alarm function indicators** - when the set time of cooking ends, the signal sounds.



The function is on.



The function is on.  
Cooking stops automatically.



Sound alarm is off.

**Timer indicators**



To set the function: Delayed start.



To cancel the setting.

## 5. BEFORE FIRST USE

### **WARNING!**

Refer to Safety chapters.

## 5.1 Initial Cleaning



### Step 1

Remove all accessories and removable shelf supports from the appliance.



### Step 2

Clean the appliance and the accessories only with a microfibre cloth, warm water and a mild detergent.



### Step 3

Place the accessories and the removable shelf supports in the appliance.

## 5.2 First connection

The display shows welcome message after the first connection.

You have to set: Language, Display Brightness, Key Tones, Buzzer Volume, Time of Day.

## 5.3 Initial preheating

Preheat the empty oven before the first use.

**Step 1** Remove all accessories and removable shelf supports from the oven.

**Step 2** Set the maximum temperature for the function:   
Let the oven operate for 1 h.

**Step 3** Set the maximum temperature for the function:   
Let the oven operate for 15 min.

 The oven can emit an odour and smoke during preheating. Make sure that the room is ventilated.

## 6. DAILY USE

### **WARNING!**

Refer to Safety chapters.

## 6.1 How to set: Heating functions

**Step 1** Turn on the oven. The display shows the default heating function.

**Step 2** Press the symbol of the heating function  to enter the submenu.

**Step 3** Select the heating function and press: **OK**. The display shows: temperature.

**Step 4** Set: temperature. Press: **OK**.

---

**Step 5**

Press: **START** .  
Food Sensor - you can plug the sensor at any time before or during cooking.

---

**STOP** - press to turn off the heating function.

---

**Step 6**

Turn off the oven.

---

## 6.2 How to set: Assisted Cooking

Every dish in this submenu has a recommended function and temperature. You can adjust the time and the temperature.

For some of the dishes you can also cook with:

- Weight Automatic
- Food Sensor

The degree to which a dish is cooked:

- Rare or Less
  - Medium
  - Well Done or More
- 

**Step 1**

Turn on the oven.

---

**Step 2**

Press: .

---

**Step 3**

Press:  . Enter: Assisted Cooking.

---

**Step 4**

Choose a dish or a food type.

---





**Step 5**

Press: **START** .





---

## 6.3 Heating functions







### STANDARD



Heating function	Application
 Grill	To grill thin pieces of food and to toast bread.
 Turbo Grilling	To roast large meat joints or poultry with bones on one shelf position. To make gratins and to brown.
 True Fan Cooking	To bake on up to three shelf positions at the same time and to dry food. Set the temperature 20 - 40 °C lower than for Conventional Cooking.
 Frozen Foods	To make convenience food crispy, e.g. french fries, potato wedges or spring rolls.

---

Heating function	Application
 <b>Conventional Cooking</b>	To bake and roast food on one shelf position.
 <b>Pizza Function</b>	To bake pizza. To make intensive browning and a crispy bottom.
 <b>Bottom Heat</b>	To bake cakes with crispy bottom and to preserve food.
 <b>Bread Baking</b>	Use this function to prepare bread and bread rolls with a very good professional-like result in terms of crispiness, colour and crust gloss.
 <b>Dough Proving</b>	To speed up the rising of the yeast dough. It prevents dough surface from drying and keeps the dough elastic.

## SPECIALS

Heating function	Application
 <b>Preserving</b>	To preserve vegetables (e.g., pickles).
 <b>Dehydrating</b>	To dry sliced fruit, vegetables and mushrooms.
 <b>Plate Warming</b>	To preheat plates for serving.
 <b>Defrost</b>	To defrost food (vegetables and fruit). The defrosting time depends on the amount and size of the frozen food.
 <b>Au Gratin</b>	For dishes such as lasagna or potato gratin. To make gratins and to brown.
 <b>Slow Cooking</b>	To prepare tender, succulent roasts.

Heating function	Application
 <p><b>Keep Warm</b></p>	To keep food warm. Please note that some dishes may continue to cook and dry out while being kept warm. Cover the dishes if necessary
 <p><b>Moist Fan Baking</b></p>	This function is designed to save energy during cooking. When you use this function, the temperature inside the appliance may differ from the set temperature. The residual heat is used. The heating power may be reduced. For more information refer to "Daily Use" chapter, Notes on: Moist Fan Baking.

## 6.4 Notes on: Moist Fan Baking

This function was used to comply with the energy efficiency class and ecodesign requirements (according to EU 65/2014 and EU 66/2014). Tests according to: IEC/EN 60350-1.

The oven door should be closed during cooking so that the function is not interrupted and the oven operates with the highest energy efficiency possible.

When you use this function the lamp automatically turns off after 30 sec.

For the cooking instructions refer to "Hints and tips" chapter, Moist Fan Baking. For general energy saving recommendations refer to "Energy Efficiency" chapter, Energy Saving.

## 7. CLOCK FUNCTIONS

### 7.1 Clock functions description

Clock function	Application
Cooking time	To set the length of cooking. Maximum is 23 h 59 min.
End Action	To set what happens when the timer ends counting.
Delayed start	To postpone the start and / or end of cooking.
Time Extension	To extend cooking time.
Reminder	To set a countdown. Maximum is 23 h 59 min. This function has no effect on the operation of the appliance.
Uptimer	Monitors how long the function operates. Uptimer - you can turn it on and off.

### 7.2 How to set: Clock functions

How to set the clock	
<b>Step 1</b>	Turn on the oven.
<b>Step 2</b>	Press: Time of Day.
<b>Step 3</b>	Set the time. Press: <b>OK</b> .

### How to set cooking time

**Step 1** Choose the heating function and set the temperature.

**Step 2** Press: .

**Step 3** Set the time. Press: **OK**.

### How to choose end option

**Step 1** Choose the heating function and set the temperature.

**Step 2** Press: .

**Step 3** Set the cooking time.

**Step 4** Press: ● ● ●.

**Step 5** Press: End Action.

**Step 6** Choose the preferred: End Action.

**Step 7** Press: **OK**. Repeat the action until the display shows the main screen.

### How to delay start of cooking

**Step 1** Set the heating function and the temperature.

**Step 2** Press: .

**Step 3** Set the cooking time.

**Step 4** Press: ● ● ●.

**Step 5** Press: Delayed start.

**Step 6** Choose the value.

**Step 7** Press: **OK**. Repeat the action until the display shows the main screen.

### How to extend cooking time

When 10% of cooking time is left and the food seems not to be ready, you can extend cooking time. You can also change the heating function.

Press **+1min** to extend the cooking time.

### How to change timer settings

**Step 1** Press: .

**Step 2** Set the timer value.

**Step 3** Press: **OK**.

You can change the set time during cooking at any time.

## 8. USING THE ACCESSORIES

### **WARNING!**

Refer to Safety chapters.

### 8.1 Inserting accessories

A small indentation at the top increases safety. The indentations are also anti-tip

devices. The high rim around the shelf prevents cookware from slipping of the shelf.

#### **Wire shelf:**

Push the shelf between the guide bars of the shelf support.

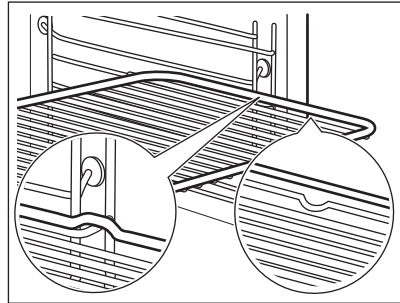

#### **Baking tray / Deep pan:**

Push the tray between the guide bars of the shelf support.

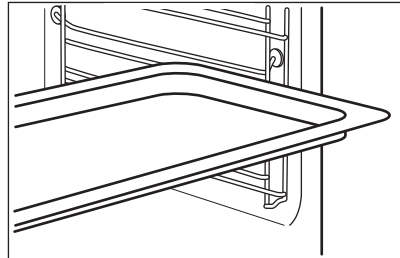

### 8.2 Food Sensor

Food Sensor - measures the temperature inside the food. You can use it with every heating function.

**There are two temperatures to be set:**



The oven temperature: minimum 120 °C.



The core temperature.

**For the best cooking results:**

Ingredients should be at room temperature. Do not use it for liquid dishes. During cooking it must remain in the dish.

The oven calculates an approximate end of cooking time. It depends on the quantity of food, the set oven function and the temperature.

## 8.3 How to use: Food Sensor

- 
- Step 1** Turn on the oven.
- 
- Step 2** Set a heating function and, if necessary, the oven temperature.
- 
- Step 3** Insert: Food Sensor.
- 

### Meat, poultry and fish

### Casserole

Insert the tip of Food Sensor into the centre of meat, fish, in the thickest part if possible. Make sure that at least 3/4 of Food Sensor is inside of the dish.

Insert the tip of Food Sensor exactly in the centre of the casserole. Food Sensor should be stabilized in one place during baking. Use a solid ingredient to achieve that. Use the rim of the baking dish to support the silicone handle of Food Sensor. The tip of Food Sensor should not touch the bottom of a baking dish.

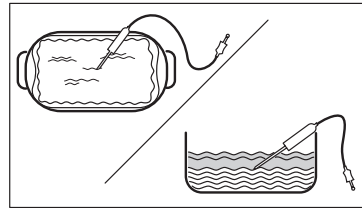
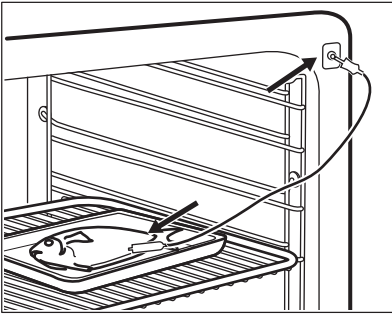

- 
- Step 4** Plug Food Sensor into the socket at the front of the oven.  
The display shows the current temperature of: Food Sensor.
- 
- Step 5**  - press to set the core temperature of the sensor.
- 
- Step 6**
- ● ● - press to set the preferred option:
  - Sound Alarm - when food reaches the core temperature, the signal sounds.
  - Sound Alarm and stop cooking - when food reaches the core temperature, the signal sounds and the oven stops.
- 
- Step 7** Select the option and repeatedly press: **OK** to go to main screen.
- 
- Step 8** Press: **START**.  
When food reaches the set temperature, the signal sounds. You can choose to stop or to continue cooking to make sure the food is well done.
- 
- Step 9** Remove Food Sensor plug from the socket and remove the dish from the oven.

 **WARNING!**

There is a risk of burns as Food Sensor becomes hot. Be careful when you unplug it and remove it from the food.





## 9. ADDITIONAL FUNCTIONS

### 9.1 How to save: Favourites

You can save your favourite settings, such as the heating function, the cooking time, the temperature or the cleaning function. You can save 3 favourite settings.



- 
- Step 1** Turn on the appliance.
- 
- Step 2** Select the preferred setting.
- 
- Step 3** Press: . Select: Favourites.
- 
- Step 4** Select: Save current settings.
- 
- Step 5** Press **+** to add the setting to the list of: Favourites. Press **OK**.

 - press to reset the setting.

 - press to cancel the setting.

### 9.2 Function lock



This function prevents an accidental change of the heating function.



- 
- Step 1** Turn on the appliance.
- 
- Step 2** Set a heating function.
- 
- Step 3** ,  - press at the same time to turn on the function.

To turn off the function repeat step 3.

### 9.3 Automatic switch-off

For safety reasons, if the heating function is active and no settings are changed, the appliance will turn off automatically after a certain period of time.

 (°C)	 (h)
30 - 115	12.5
120 - 195	8.5
200 - 245	5.5

 (°C)	 (h)
250 - maximum	3

The Automatic switch-off does not work with the functions: Light, Food Sensor, End time, Slow Cooking.

### 9.4 Cooling fan

When the appliance operates, the cooling fan turns on automatically to keep the surfaces of the appliance cool. If you turn off the appliance, the cooling fan can continue to operate until the appliance cools down.

## 10. HINTS AND TIPS

### 10.1 Cooking recommendations



The temperature and cooking times in the tables are guidelines only. They depend on the recipes and the quality and quantity of the ingredients used.





Your appliance may bake or roast differently to the appliance you had before. The hints below show recommended settings for temperature, cooking time and shelf position for specific types of the food.

If you cannot find the settings for a special recipe, look for the similar one.

For more cooking recommendations refer to cooking tables on our website. To find the Cooking Hints, check the PNC number on the rating plate on the front frame of the appliance cavity.

### 10.2 Moist Fan Baking

For the best results follow suggestions listed in the table below.

		°C		
Sweet rolls, 16 pieces	baking tray or dripping pan	180	2	25 - 35
Swiss Roll	baking tray or dripping pan	180	2	15 - 25
Whole fish, 0.2 kg	baking tray or dripping pan	180	3	15 - 25
Cookies, 16 pieces	baking tray or dripping pan	180	2	20 - 30
Macarons, 24 pieces	baking tray or dripping pan	160	2	25 - 35
Muffins, 12 pieces	baking tray or dripping pan	180	2	20 - 30
Savory pastry, 20 pieces	baking tray or dripping pan	180	2	20 - 30
Short crust biscuits, 20 pieces	baking tray or dripping pan	140	2	15 - 25
Tartlets, 8 pieces	baking tray or dripping pan	180	2	15 - 25

### 10.3 Moist Fan Baking - recommended accessories

Use the dark and non-reflective tins and containers. They have better heat absorption than the light colour and reflective dishes.



Pizza pan

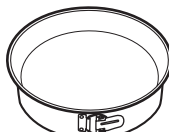

Baking dish



Ramekins



Flan base tin

Dark, non-reflective  
28 cm diameter

Dark, non-reflective  
26 cm diameter

Ceramic  
8 cm diameter, 5  
cm height





Dark, non-reflective  
28 cm diameter

## 10.4 Cooking tables for test institutes

### Information for test institutes





Tests according to: EN 60350, IEC 60350.

Baking on one level - baking in tins





		 °C	 min	
Fatless sponge cake	True Fan Cooking	160	45 - 60	2
Fatless sponge cake	Conventional Cooking	160	45 - 60	2
Apple pie, 2 tins Ø20 cm	True Fan Cooking	160	55 - 65	2
Apple pie, 2 tins Ø20 cm	Conventional Cooking	180	55 - 65	1
Short bread	True Fan Cooking	140	25 - 35	2
Short bread	Conventional Cooking	140	25 - 35	2





Baking on one level - biscuits

Use the third shelf position.





		 °C	 min	
Small cakes, 20 per tray, preheat the empty oven	True Fan Cooking	150	20 - 30	
Small cakes, 20 per tray, preheat the empty oven	Conventional Cooking	170	20 - 30	

Multilevel baking - biscuits

		 °C	 min	
Short bread	True Fan Cooking	140	25 - 45	2 / 4
Small cakes, 20 per tray, pre-heat the empty oven	True Fan Cooking	150	25 - 35	1 / 4
Fatless sponge cake	True Fan Cooking	160	45 - 55	2 / 4

		 °C	 min	
Apple pie, 1 tin per grid (Ø 20 cm)	True Fan Cooking	160	55 - 65	2 / 4

Grill  
Preheat the empty oven for 5 minutes.  
Grill with the maximum temperature setting.

		 min	
Toast	Grill	1 - 2	5
Beef steak, turn halfway through	Grill	24 - 30	4

## 11. CARE AND CLEANING

### **WARNING!**

Refer to Safety chapters.

### 11.1 Notes on cleaning



#### Cleaning Agents

Clean the front of the appliance only with a microfibre cloth with warm water and a mild detergent.

Use a cleaning solution to clean metal surfaces.

Clean stains with a mild detergent.



#### Everyday Use

Clean the cavity after each use. Fat accumulation or other residue may cause fire.

Do not store the food in the appliance for longer than 20 minutes. Dry the cavity only with a microfibre cloth after each use.



#### Accessories

Clean all accessories after each use and let them dry. Use only a microfibre cloth with warm water and a mild detergent. Do not clean the accessories in a dishwasher.

Do not clean the non-stick accessories using abrasive cleaner or sharp-edged objects.

### 11.2 How to remove: Shelf supports

Remove the shelf supports to clean the oven.

**Step 1** Turn off the oven and wait until it is cold.

**Step 2** Pull the front of the shelf support away from the side wall.

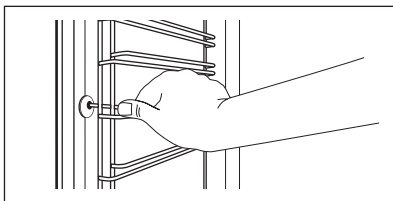

**Step 3** Pull the rear end of the shelf support away from the side wall and remove it.

**Step 4** Install the shelf supports in the opposite sequence. The retaining pins on the telescopic runners must point to the front.

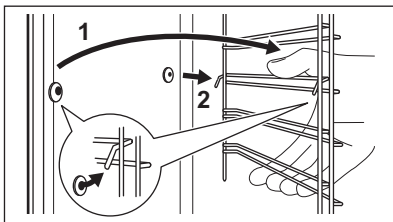

### 11.3 How to use: Pyrolytic Cleaning

Clean the oven with Pyrolytic Cleaning.

**⚠ WARNING!**

There is a risk of burns.

**⚠ CAUTION!**

If there are other appliances installed in the same cabinet, do not use them at the same time as this function. It can cause damage to the oven.

#### Before the Pyrolytic Cleaning:

Turn off the oven and wait until it is cold.

Remove all accessories and removable shelf supports.

Clean the oven floor and the inner door glass with warm water, a soft cloth and a mild detergent.

Step 1	Step 2	Step 3
Turn on the oven.	Press:  / Cleaning.	Select the cleaning mode.
Option	Cleaning mode	Duration
Pyrolytic cleaning, quick	Light cleaning	1 h
Pyrolytic cleaning, normal	Normal cleaning	1 h 30 min
Pyrolytic cleaning, intense	Thorough cleaning	3 h

**i** When the cleaning starts, the oven door is locked and the lamp is off. The cooling fan works at a higher speed.

**STOP** - press to stop the cleaning before it is completed.  
Do not use the oven until the door lock symbol disappears from the display.

#### When the cleaning ends:

Turn off the oven and wait until it is cold.

Clean the cavity with a soft cloth.

Remove the residue from the bottom of the cavity.

## 11.4 Cleaning Reminder

When the reminder appears, cleaning is recommended.

Use the function: Pyrolytic Cleaning.

## 11.5 How to remove and install: Door

You can remove the door and the internal glass panels to clean it. The number of glass panels is different for different models.

### ⚠ WARNING!

The door is heavy.

### ⚠ CAUTION!

Carefully handle the glass, especially around the edges of the front panel. The glass can break.

**Step 1** Fully open the door.

**Step 2** Lift and press the clamping levers (A) on the two door hinges.

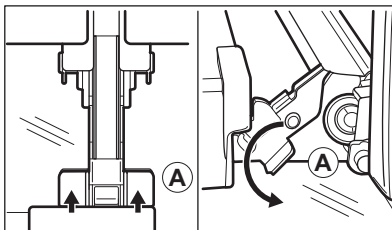

**Step 3** Close the oven door to the first opening position (approximately 70° angle). Hold the door at both sides and pull it away from the oven at an upwards angle. Put the door with the outer side down on a soft cloth on a stable surface.

**Step 4** Hold the door trim (B) on the top edge of the door at the two sides and push inwards to release the clip seal.

**Step 5** Pull the door trim to the front to remove it.

**Step 6** Hold the door glass panels on their top edge one by one and pull them up out of the guide.

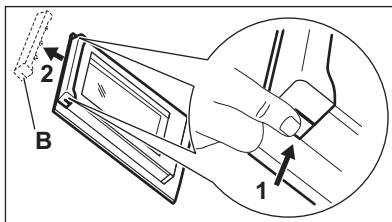

**Step 7** Clean the glass panel with water and soap. Dry the glass panel carefully. Do not clean the glass panels in the dishwasher.

**Step 8** After cleaning, do the above steps in the opposite sequence.

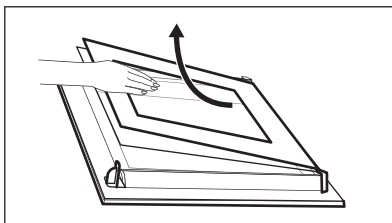

**Step 9** Install the smaller panel first, then the larger and the door.

## 11.6 How to replace: Lamp

**⚠ WARNING!**

Risk of electric shock.  
The lamp can be hot.

### Before you replace the lamp:

Step 1	Step 2	Step 3
Turn off the oven. Wait until the oven is cold.	Disconnect the oven from the mains.	Put a cloth on the bottom of the cavity.

### Top lamp

**Step 1** Turn the glass cover to remove it.

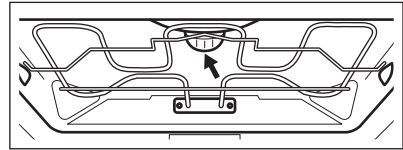

**Step 2** Clean the glass cover.

**Step 3** Replace the lamp with a suitable 300 °C heat-resistant lamp.

**Step 4** Install the glass cover.

### Side lamp

**Step 1** Remove the left shelf support to get access to the lamp.

**Step 2** Use a narrow, blunt object (e.g. a teaspoon) to remove the glass cover.

**Step 3** Clean the glass cover.

**Step 4** Replace the lamp with a suitable 300 °C heat-resistant lamp.

**Step 5** Install the glass cover.

**Step 6** Install the left shelf support.

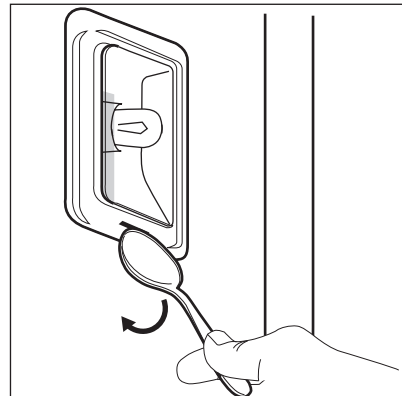

## 12. TROUBLESHOOTING

### **WARNING!**

Refer to Safety chapters.

### 12.1 What to do if...



#### The appliance does not turn on or does not heat up



#### Possible cause

The appliance is not connected to an electrical supply or it is connected incorrectly.

The clock is not set.

The door is not closed correctly.

The fuse is blown.

The appliance Child Lock is on.



#### Remedy

Check if the appliance is correctly connected to the electrical supply.

Set the clock, for details refer to Clock functions chapter, How to set: Clock functions.

Fully close the door.

Make sure the fuse is the cause of the problem. If the problem recurs, contact a qualified electrician.

Refer to "Menu" chapter, Submenu for: Options.



#### Components



#### Description

The lamp is burnt out.



#### Remedy

Replace the lamp, for details refer to "Care and Cleaning" chapter, How to replace: Lamp.

Power cut always stops cleaning. Repeat cleaning if it's interrupted by power failure.

### 12.2 How to manage: Error codes

When the software error occurs, the display shows error message.

In this section, you will find the list of the problems that you can handle on your own.



#### Code and description

C2 - the Food Sensor is in the appliance cavity during Pyrolytic Cleaning.

C3 - the door is not fully closed during Pyrolytic Cleaning.



#### Remedy

Take out the Food Sensor.

Close the door.





### Code and description



### Remedy

F111 - Food Sensor is not correctly inserted into the socket.

Fully plug Food Sensor into the socket.

F240, F439 - the touch fields on the display do not work properly.

Clean the surface of the display. Make sure there is no dirt on the touch fields.

F908 - the appliance system cannot connect with the control panel.

Turn the appliance off and on.

## 12.3 Service data

If you cannot find a solution to the problem yourself, contact your dealer or an Authorised Service Centre.

The necessary data for the service centre is on the rating plate. The rating plate is on the front frame of the appliance cavity. Do not remove the rating plate from the appliance cavity.

### We recommend that you write the data here:

Model (MOD.)	.....
Product number (PNC)	.....
Serial number (S.N.)	.....

## 13. ENERGY EFFICIENCY

### 13.1 Product Information and Product Information Sheet according to EU Ecodesign and Energy Labelling Regulations

Supplier's name	Electrolux	
Model identification	KOEBP39X 944032077 KOEBP39Z 944032074	
Energy Efficiency Index	61.2	
Energy efficiency class	A++	
Energy consumption with a standard load, conventional mode	1.09 kWh/cycle	
Energy consumption with a standard load, fan-forced mode	0.52 kWh/cycle	
Number of cavities	1	
Heat source	Electricity	
Volume	71 l	
Type of oven	Built-In Oven	
Mass	KOEBP39X	35.0 kg
	KOEBP39Z	34.5 kg

IEC/EN 60350-1 - Household electric cooking appliances - Part 1: Ranges, ovens, steam ovens and grills - Methods for measuring performance.

## 13.2 Energy saving



The appliance has features which help you save energy during everyday cooking.

Make sure that the appliance door is closed when the appliance operates. Do not open the appliance door too often during cooking. Keep the door gasket clean and make sure it is well fixed in its position.

Use metal cookware to improve energy saving.

When possible, do not preheat the appliance before cooking.

Keep breaks between baking as short as possible when you prepare a few dishes at one time.

### Cooking with fan

When possible, use the cooking functions with fan to save energy.

### Residual heat

If a programme with Duration is activated and the cooking time is longer than 30 min, the heating elements automatically turn off earlier in some appliance functions.

The fan and lamp continue to operate. When you turn off the appliance, the display shows the residual heat. You can use that heat to keep the food warm.

When the cooking duration is longer than 30 min, reduce the appliance temperature to minimum 3 - 10 min before the end of cooking. The residual heat inside the appliance will continue to cook.

Use the residual heat to warm up other dishes.

### Keep food warm

Choose the lowest possible temperature setting to use residual heat and keep a meal warm. The residual heat indicator or temperature appears on the display.

### Cooking with the lamp off

Turn off the lamp during cooking. Turn it on only when you need it.

### Moist Fan Baking

Function designed to save energy during cooking.

When you use this function the lamp automatically turns off after 30 sec. You may turn on the lamp again but this action will reduce the expected energy savings.

## 14. MENU STRUCTURE

### 14.1 Menu

Menu item	Application
Assisted Cooking	Lists automatic programmes.
Cleaning	Lists cleaning programmes.
Favourites	Lists the favourite settings.
Options	To set the appliance configuration.
Settings	Setup Service
	To set the appliance configuration. Shows the software version and configuration.

## 14.2 Submenu for: Cleaning

Submenu	Application
Pyrolytic cleaning, quick	Duration: 1 h.
Pyrolytic cleaning, normal	Duration: 1 h 30 min.
Pyrolytic cleaning, intense	Duration: 3 h.

## 14.3 Submenu for: Options

Submenu	Application
Light	Turns the lamp on and off.
Child Lock	Prevents accidental activation of the appliance. When the option is on, the text Child Lock appears in the display when you turn on the appliance. To enable the appliance use, choose the code letters in the alphabetical order. When the option is on, and the appliance is turned off the appliance door is locked. Access to the timer, the remote operation and the lamp is available with the option on.
Fast Heat Up	Shortens the heat up time. It is available only for some of the appliance functions.
Cleaning Reminder	Turns the reminder on and off.
Time Indication	Turns the clock on and off.
Digital Clock Style	Changes the format of the displayed time indication.

## 14.4 Submenu for: Setup

Submenu	Description
Language	Sets the appliance language.
Display Brightness	Sets the display brightness.
Key Tones	Turns the tone of the touch fields on and off. It is not possible to mute the tone for: ①.
Buzzer Volume	Sets the volume of key tones and signals.
Time of Day	Sets the current time and date.

## 14.5 Submenu for: Service

Submenu	Description
Demo Mode	Activation / deactivation code: 2468
Software Version	Information about software version.
Reset All Settings	Restores factory settings.

## 15. IT'S EASY!

### Before first use you have to set:

Language      Display Brightness      Key Tones      Buzzer Volume      Time of Day

### Familiarize yourself with the basic icons on the control panel and the display:

 ON / OFF

 Menu



 Favourites

 Timer



 Food Sensor

START / STOP

### Start using the appliance



Quick start	Turn on the appliance and start cooking with the default temperature and time of the function.	Step 1	Step 2	Step 3
		Press and hold: 	 ... - select the preferred function.	Press: START .
Quick Off	Turn off the appliance, any screen or message at any time.	 - press and hold until the appliance turns off.		

### Start cooking

Step 1	Step 2	Step 3	Step 4	Step 5
	 ...		OK	START
- press to turn on the appliance.	- select the heating function.	- set the temperature.	- press to confirm.	- press to start cooking.

### Get to know how to cook quickly

Use the automatic programmes to prepare a dish quickly with the default settings:

Assisted Cooking	Step 1	Step 2	Step 3	Step 4
	Press: 	Press: 	Press:  Assisted Cooking.	Choose the dish.

### Use quick functions to set the cooking time

#### 10% Finish assist

Use 10% Finish assist to add extra time when 10% of the cooking time is left.

To extend the cooking time press **+1min**.

## 16. ENVIRONMENTAL CONCERNS

Recycle materials with the symbol . Put the packaging in relevant containers to recycle it. Help protect the environment and human

health by recycling waste of electrical and electronic appliances. Do not dispose of appliances marked with the symbol  with

the household waste. Return the product to your local recycling facility or contact your municipal office.





**electrolux.com**

867371073-D-352023



**CE**