

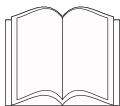

**de** Montageanleitung  
**en** Installation instructions  
**fr** Notice d'installation  
**nl** Installatie-instructies  
**it** Istruzioni d'installazione  
**el** Οδηγίες εγκατάστασης  
**es** Instrucciones de montaje  
**pt** Instruções de instalação  
**sv** Installationsanvisningar  
**no** Installasjonsveiledning  
**fi** Asennusohjeet  
**da** Installationsvejledning  
**tr** Kurulum talimatları  
**ru** Инструкция по установке  
**cs** Pokyny k instalaci  
**pl** Instrukcje montażu  
**hu** Telepítési útmutató  
**hr** Upute za instalaciju  
**mk** Упатства за инсталирање  
**sl** Navodila za montažo

**sr** Uputstva za montažu  
**et** Paigaldusjuhised  
**lt** Įrengimo instrukcijos  
**lv** Uzstādīšanas instrukcijas  
**sk** Pokyny na inštaláciu  
**sq** Udhëzimet e instalimit  
**fa** دستورالعمل نصب  
**ar** تعليمات التركيب  
**ko** 설치 설명서  
**zh** 安装说明  
**uk** Інструкція з монтажу  
**ro** Instrucțiuni de instalare  
**bg** Инструкции за монтаж  
**ja** 設置説明書  
**he** הוראות התקנה  
**id** Petunjuk pemasangan  
**kk** Орнату нұсқаулықтар  
**zh-hk** 安裝說明  
**zh-tw** 安裝說明  
**uz** O'rnatish bo'yicha yo'riqnomalar





|           |   |              |   |
|-----------|---|--------------|---|
| <b>de</b> | über den Kundendienst erhältlich                        | <b>sr</b>    | može se dobiti preko korisničkog servisa                  |
| <b>en</b> | Available from our after-sales service                  | <b>et</b>    | saadaval hooldekeskuse kaudu                              |
| <b>fr</b> | disponible via le service après-vente                   | <b>lt</b>    | galima įsigyti klientų aptarnavimo tarnyboje              |
| <b>nl</b> | bij de servicedienst verkrijgbaar                       | <b>lv</b>    | var saņemt klientu apkalpošanas dienestā                  |
| <b>it</b> | disponibile presso il servizio di assistenza clienti    | <b>sk</b>    | dostupné prostredníctvom zákazníckeho servisu             |
| <b>el</b> | διαθέσιμο από την υπηρεσία εξυπηρέτησης πελατών         | <b>sq</b>    | marrja e mundshme përmes shërbimit të klientit            |
| <b>es</b> | disponible a través del Servicio de Atención al Cliente | <b>fa</b>    | در مرکز خدمات مشتریان موجود است                           |
| <b>pt</b> | pode ser adquirido nos nossos Serviços Técnicos         | <b>ar</b>    | يمكن الحصول عليها من خدمة العملاء                         |
| <b>sv</b> | går att beställa via service                            | <b>ko</b>    | 고객 서비스센터를 통해 구입 가능  |
| <b>no</b> | fås hos kundeservice                                    | <b>zh</b>    | 可向客户服务索取  |
| <b>fi</b> | saatavissa huoltopalvelusta                             | <b>uk</b>    | Через сервісну службу                                     |
| <b>da</b> | Fås hos kundeservice                                    | <b>ro</b>    | se pot obține de la serviciul de asistență pentru clienți |
| <b>tr</b> | müşteri hizmetlerinden temin edilebilir                 | <b>bg</b>    | предоставя се от службата за обслужване на клиенти        |
| <b>ru</b> | можно приобрести через сервисную службу                 | <b>ja</b>    | カスタマーサービスを通じて入手可能   |
| <b>cs</b> | k dostání v zákaznickém servisu                         | <b>he</b>    | זמין דרך שירות הלקוחות                                    |
| <b>pl</b> | do nabycia w punkcie serwisowym                         | <b>id</b>    | Tersedia di Layanan Pelanggan                             |
| <b>hu</b> | a vevőszolgálaton keresztül kapható                     | <b>kk</b>    | сервистік қызмет арқылы алуға болады                      |
| <b>hr</b> | može se kupiti kod servisne službe                      | <b>zh-hk</b> | 可向售後服務站索取   |
| <b>mk</b> | достапно преку сервисната служба                        | <b>zh-tw</b> | 可向客戶服務單位索取  |
| <b>sl</b> | na voljo prek pooblaščenega servisa                     | <b>uz</b>    | otishdan keyingi xizmat orqali olish mumkin               |

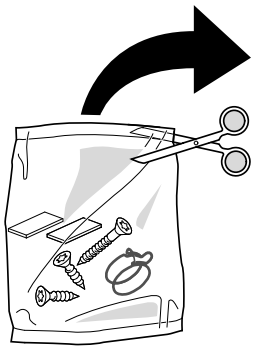

Ø4X36 Ø4X30

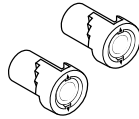
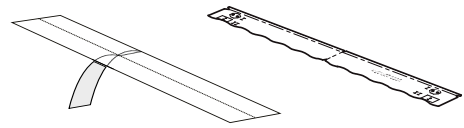
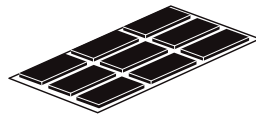
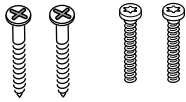

Ø4X15

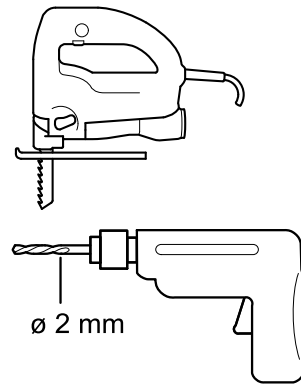
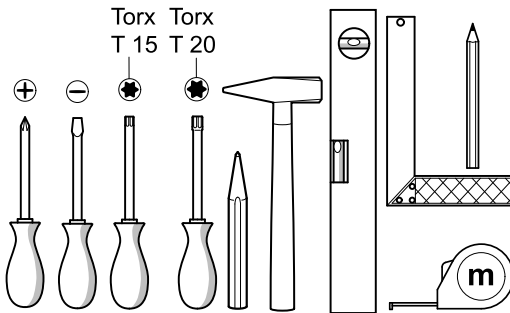
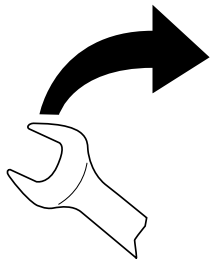
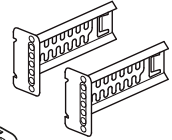
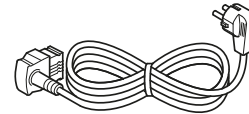
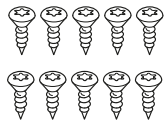

SW13

SW10

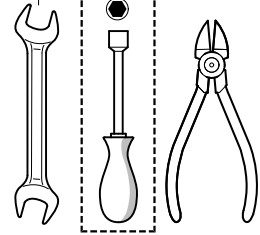

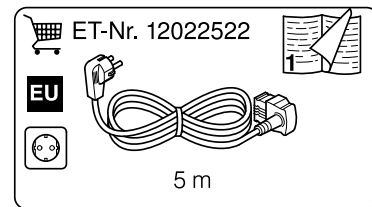
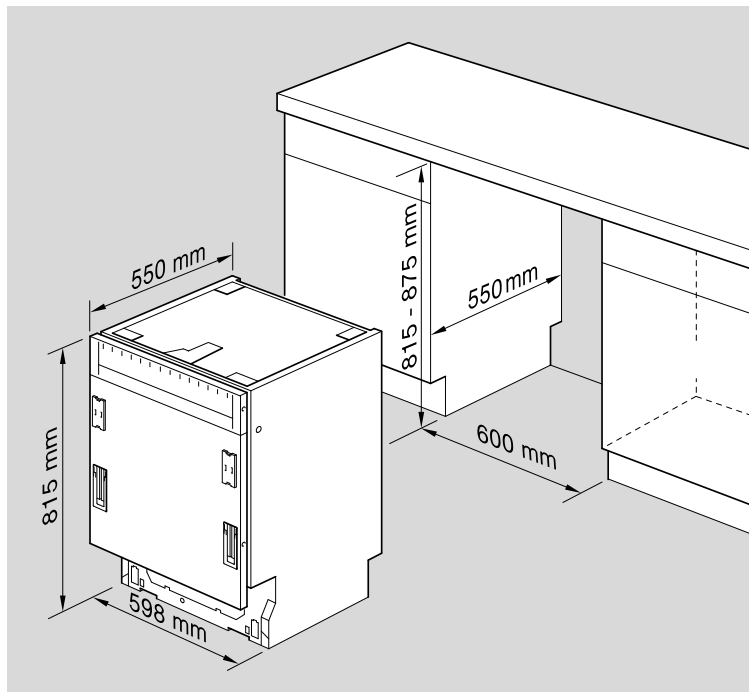
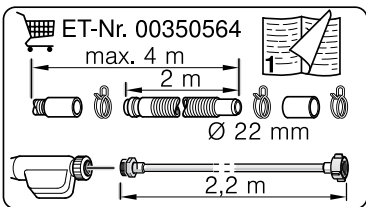
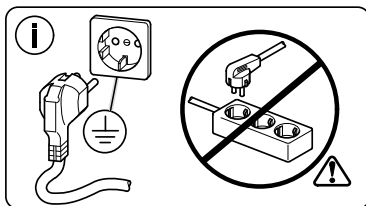
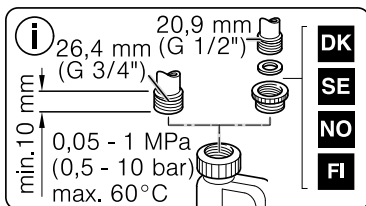
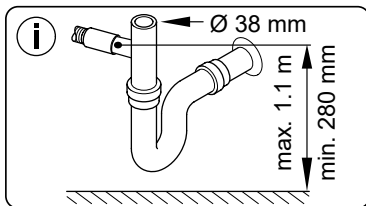

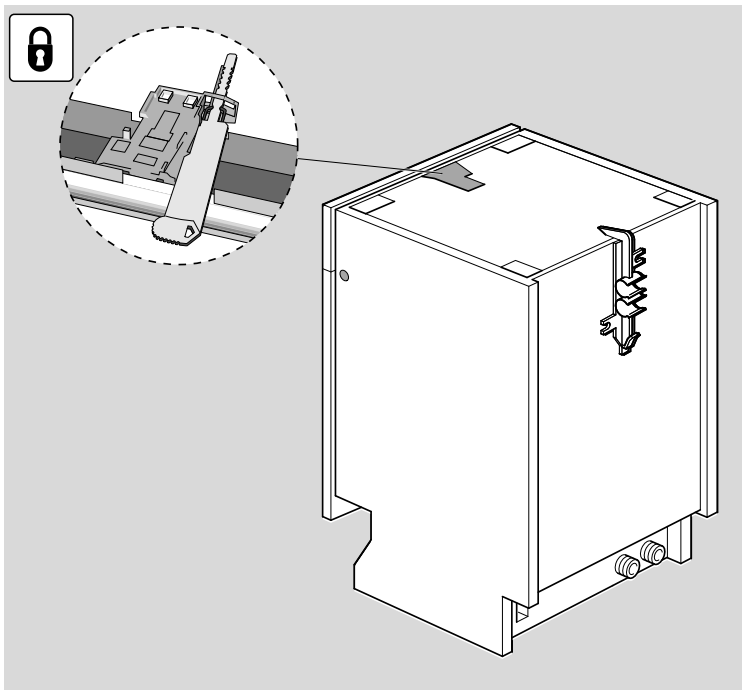
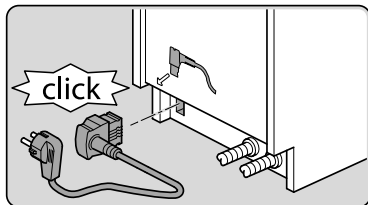
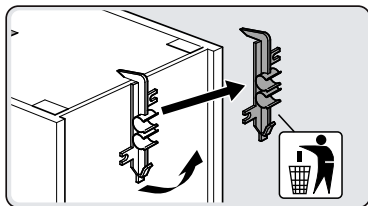
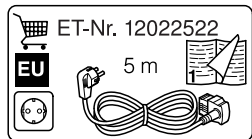
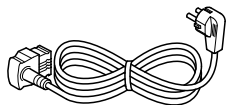

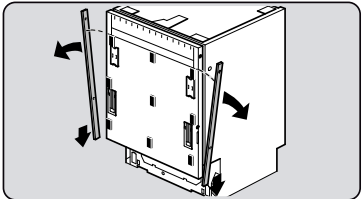
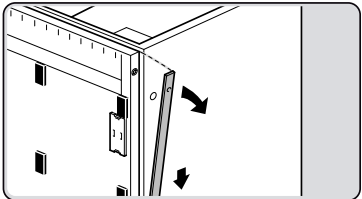
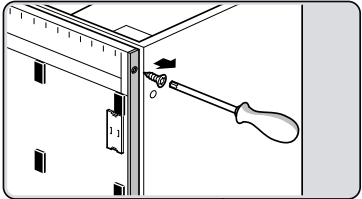
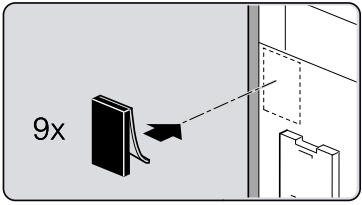
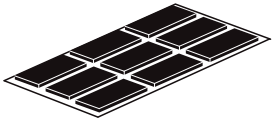

Torx  
T 15

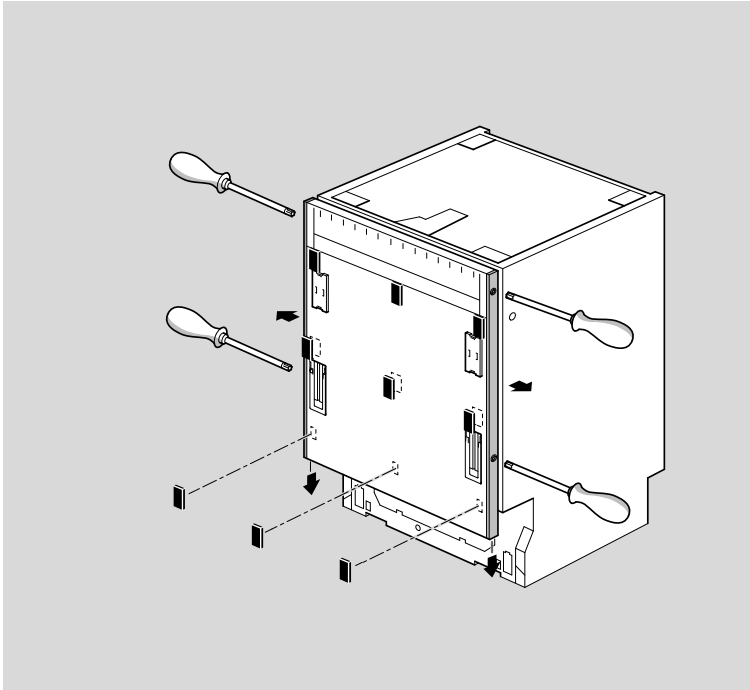
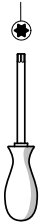

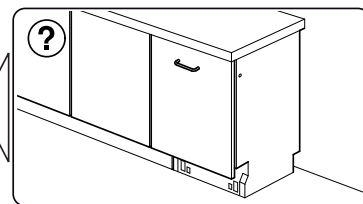
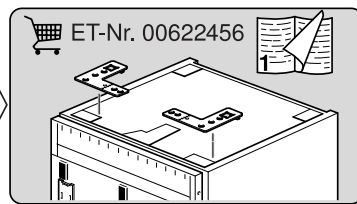
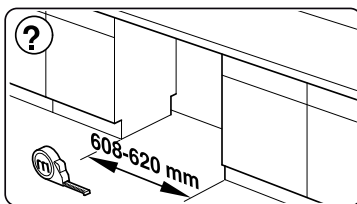
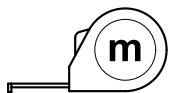
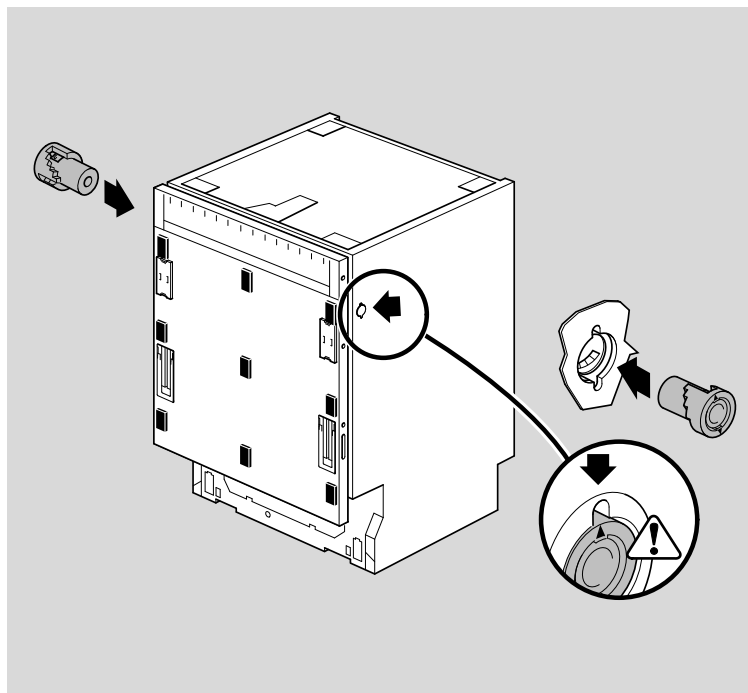
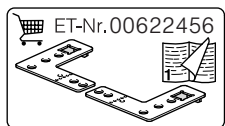
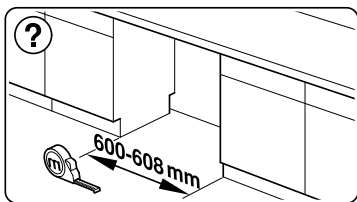
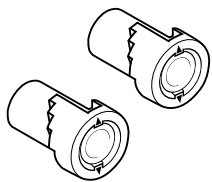

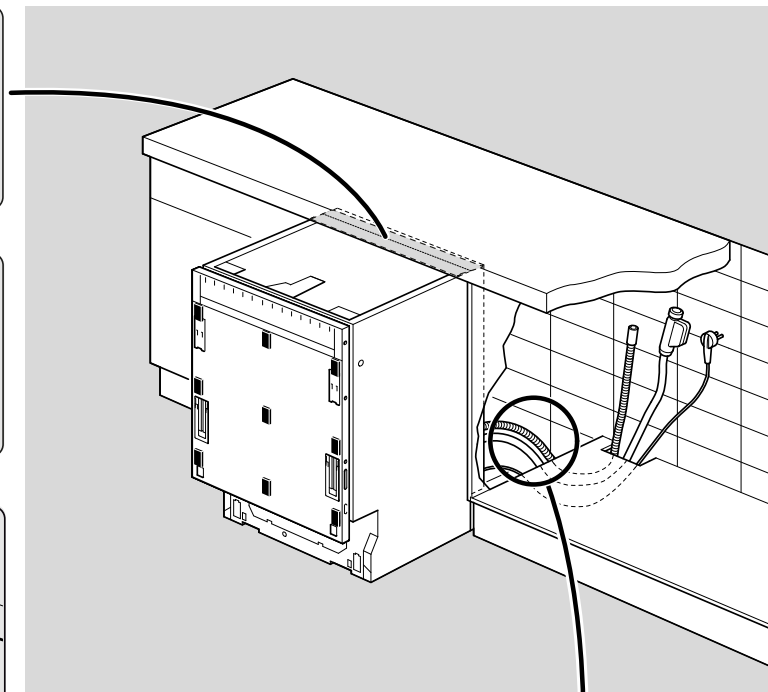
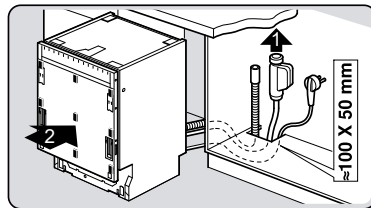
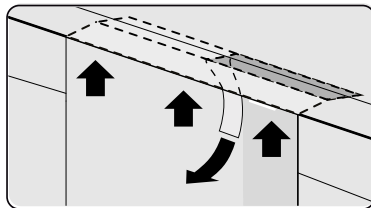
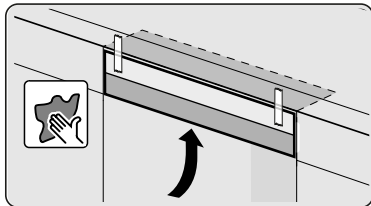
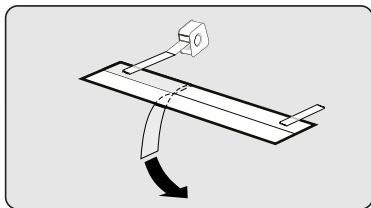
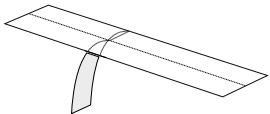

nicht einklemmen  
do not pinch  
ne pas coincer  
No doblar

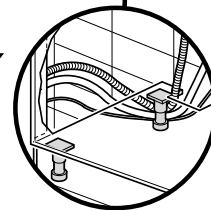



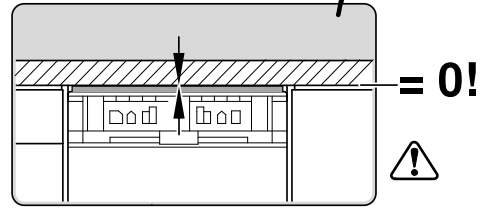
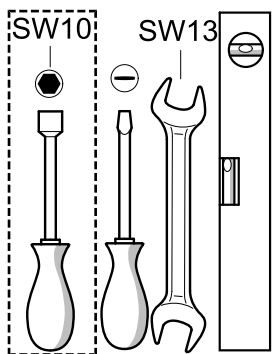
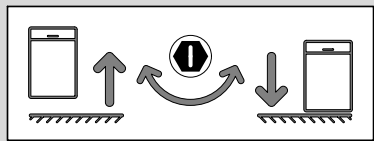
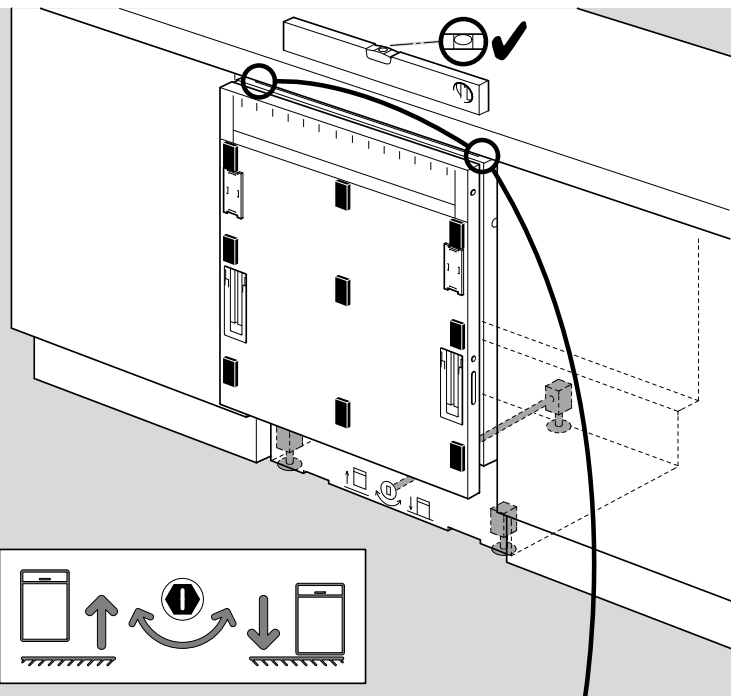
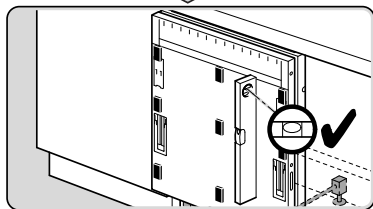
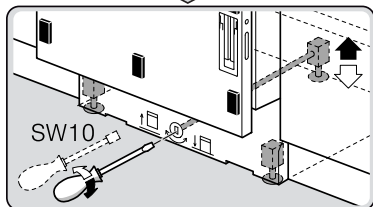
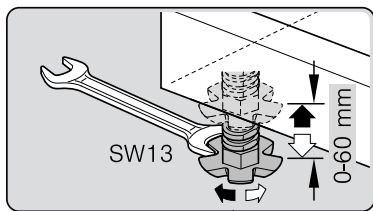

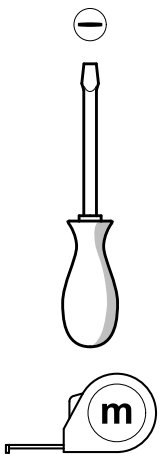
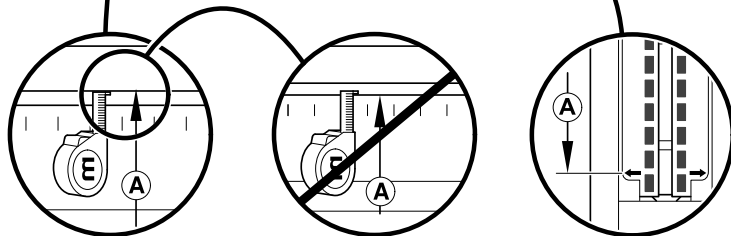
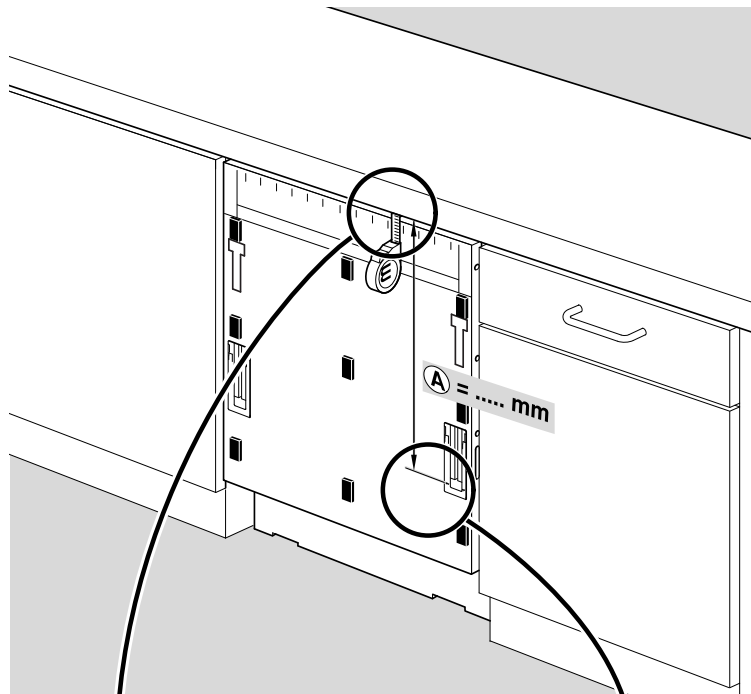
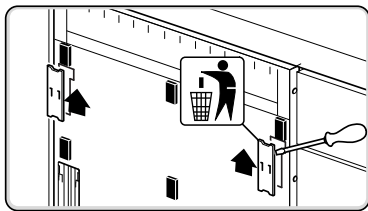

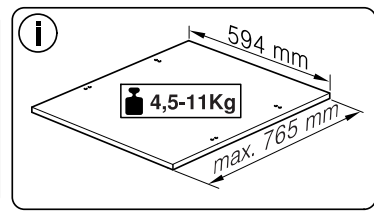
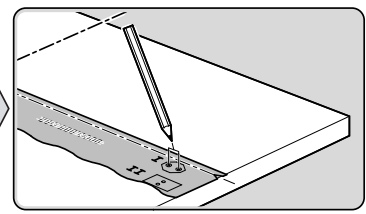
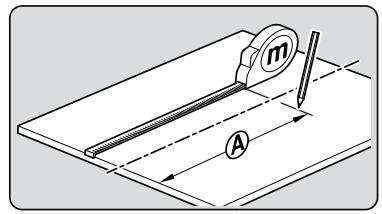
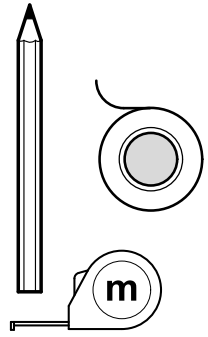
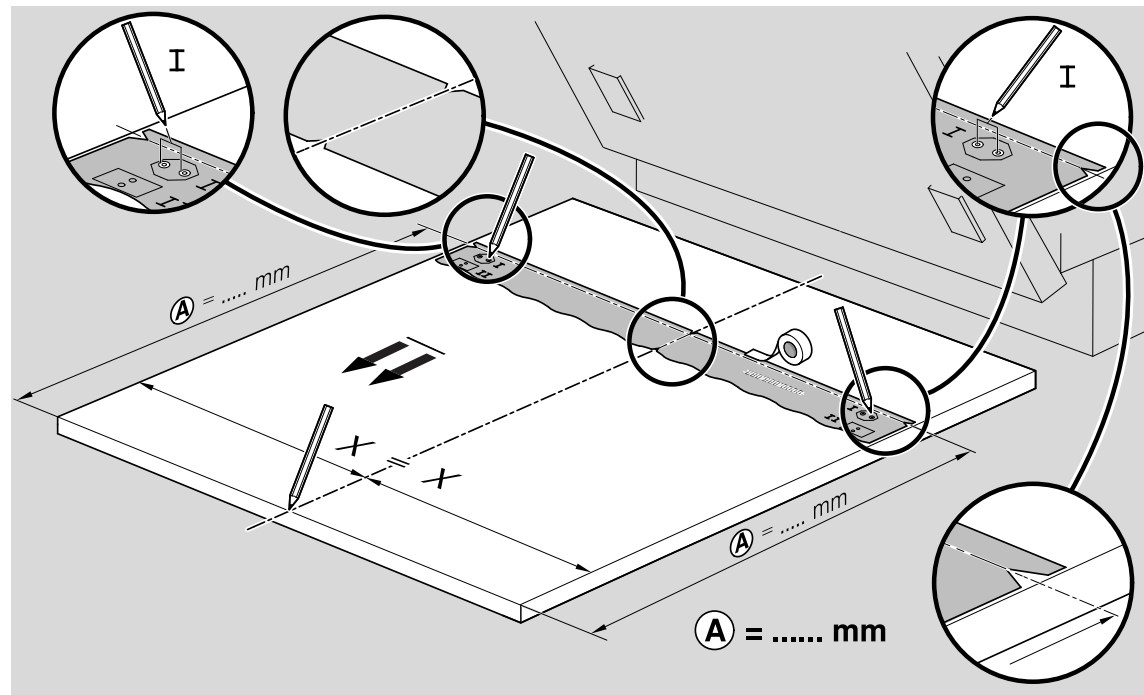
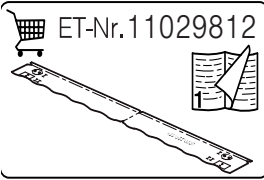
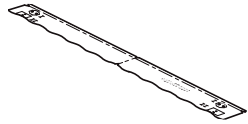

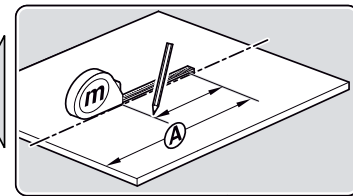
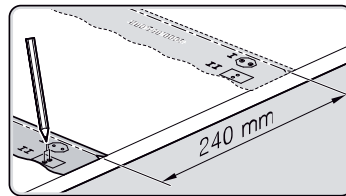
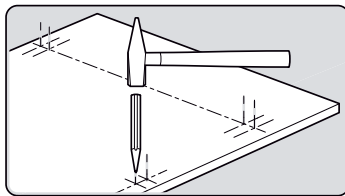
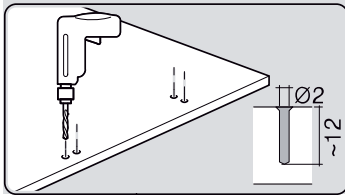
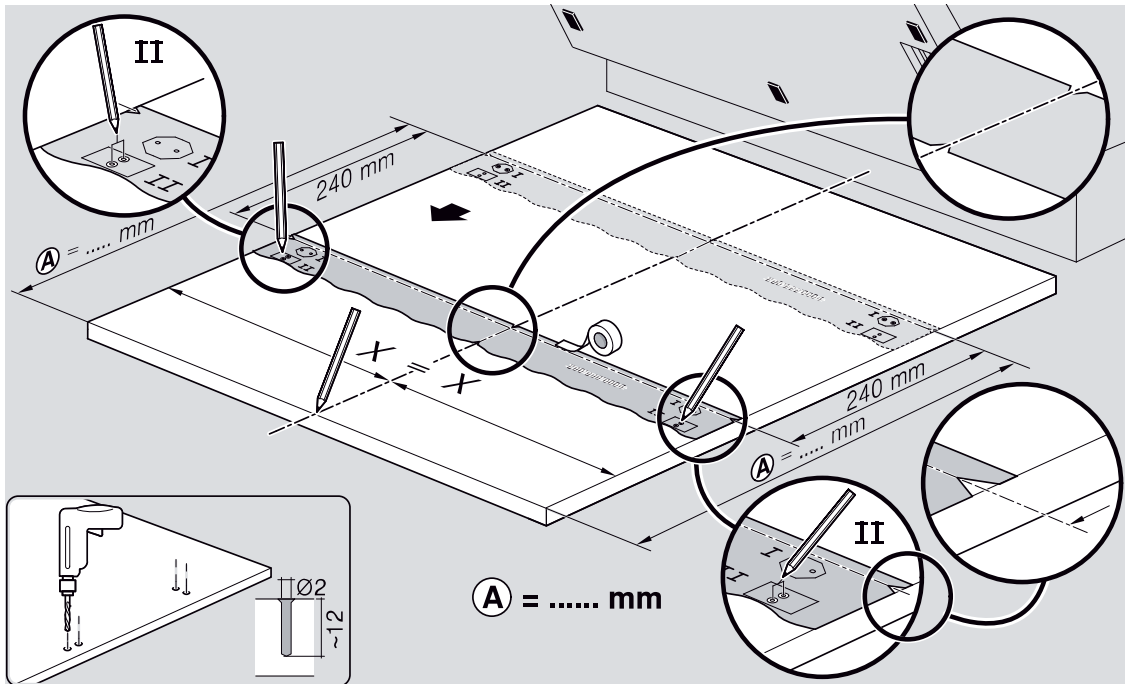
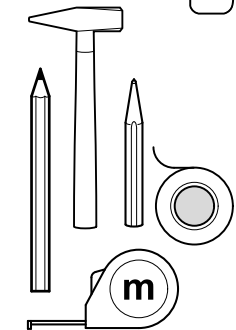
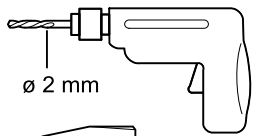
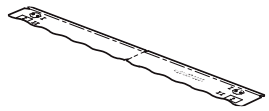

Ø4X15

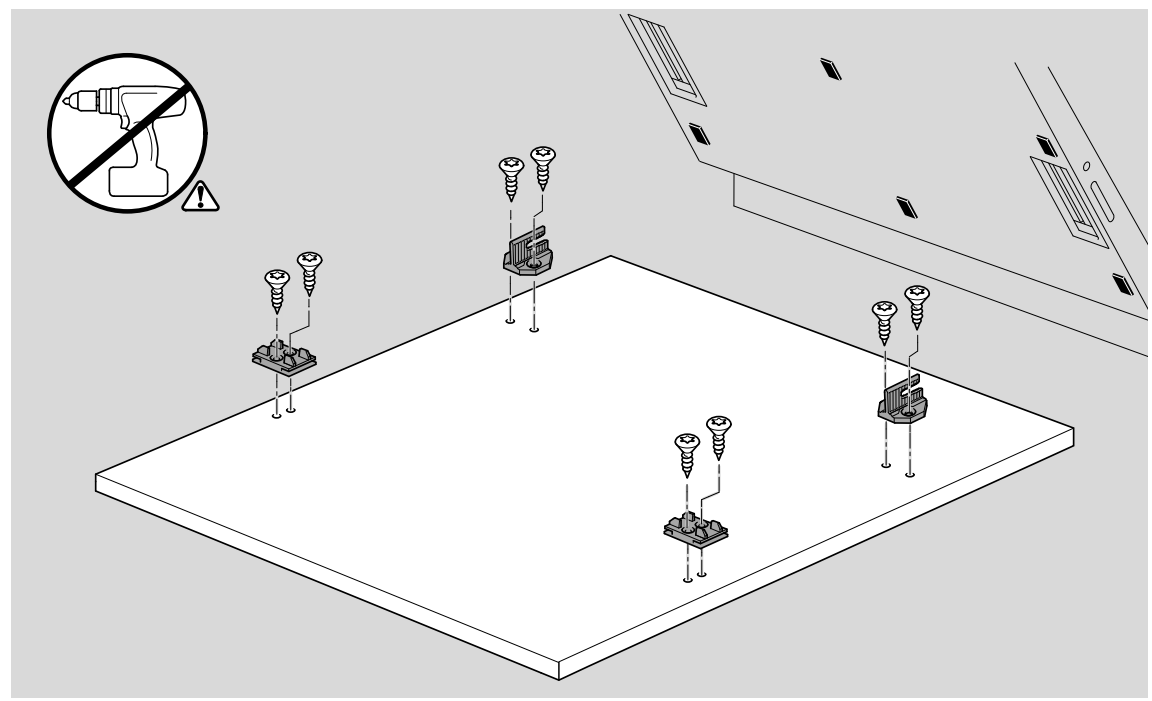
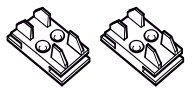

Torx  
T 20

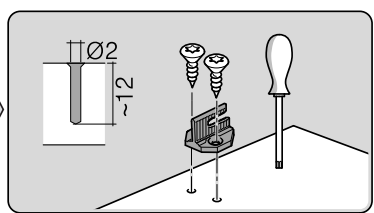
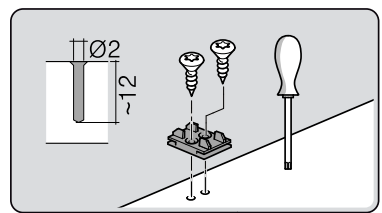
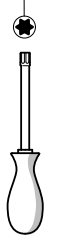

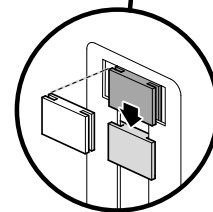
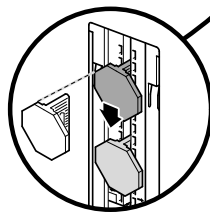
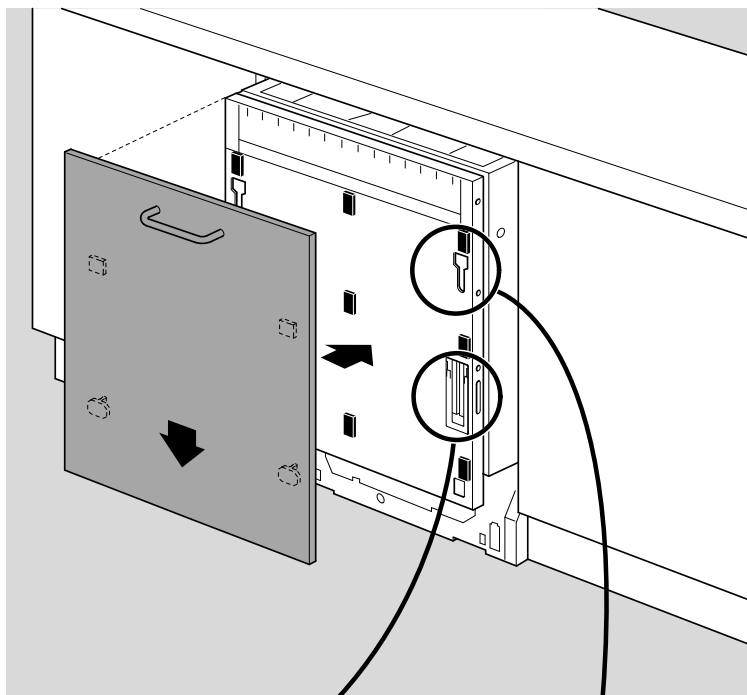
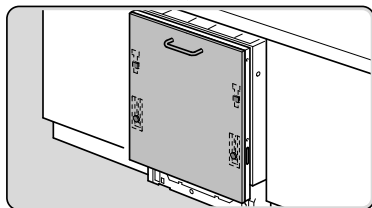
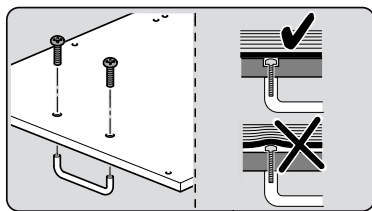

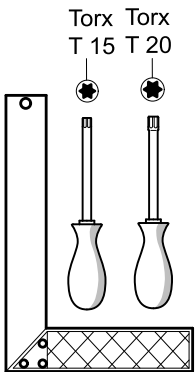
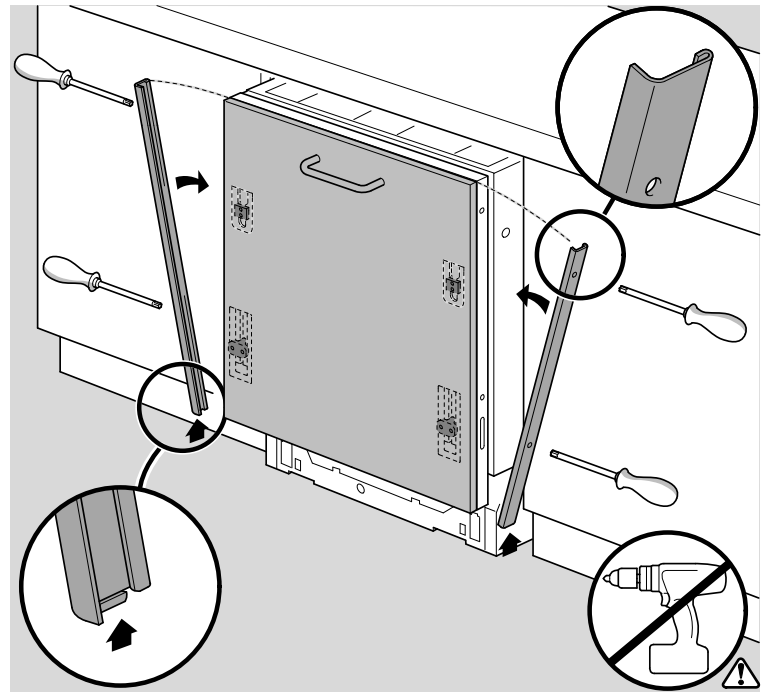
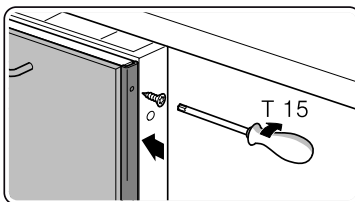
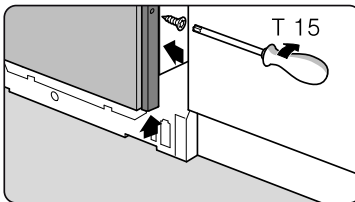
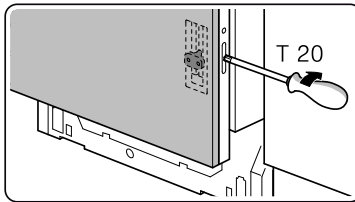
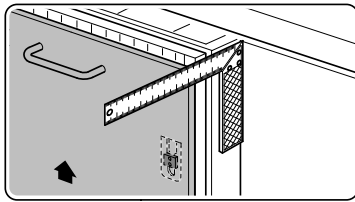

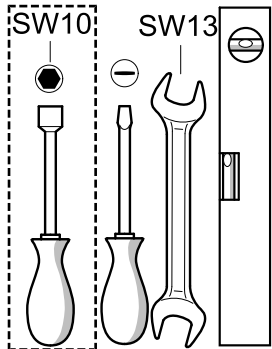
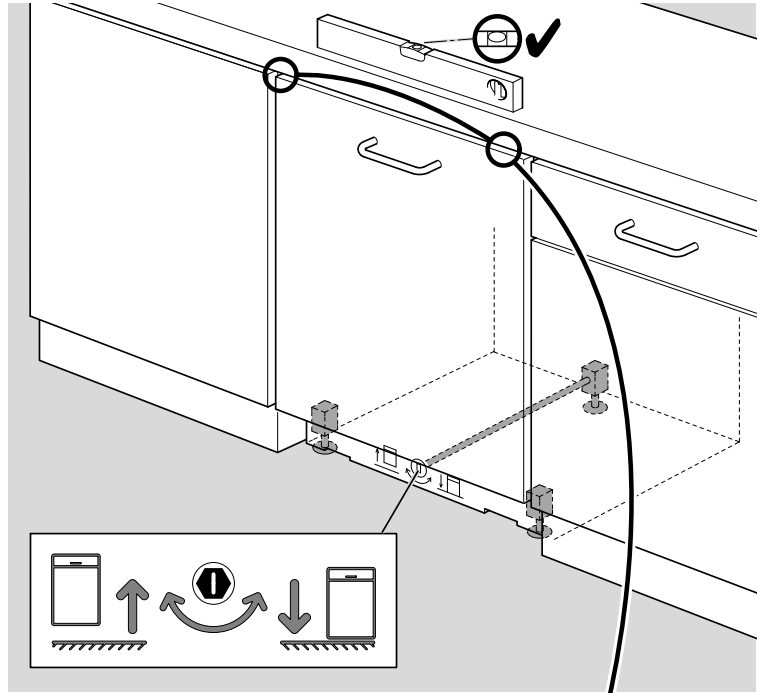
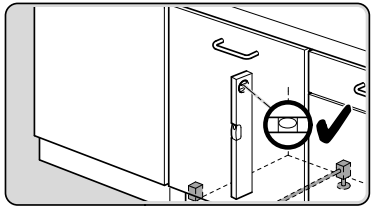
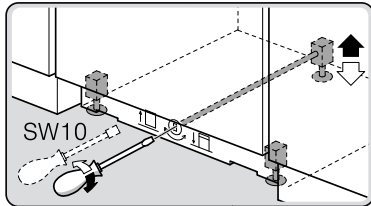
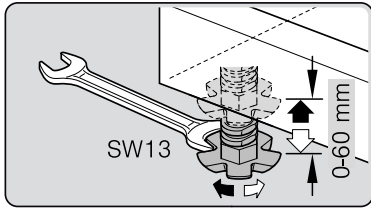

**verspannen**  
**brace**  
**calar verticalement**  
**Enrasar**

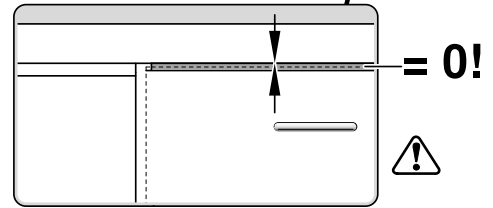



Ø4X30



Torx  
T 20

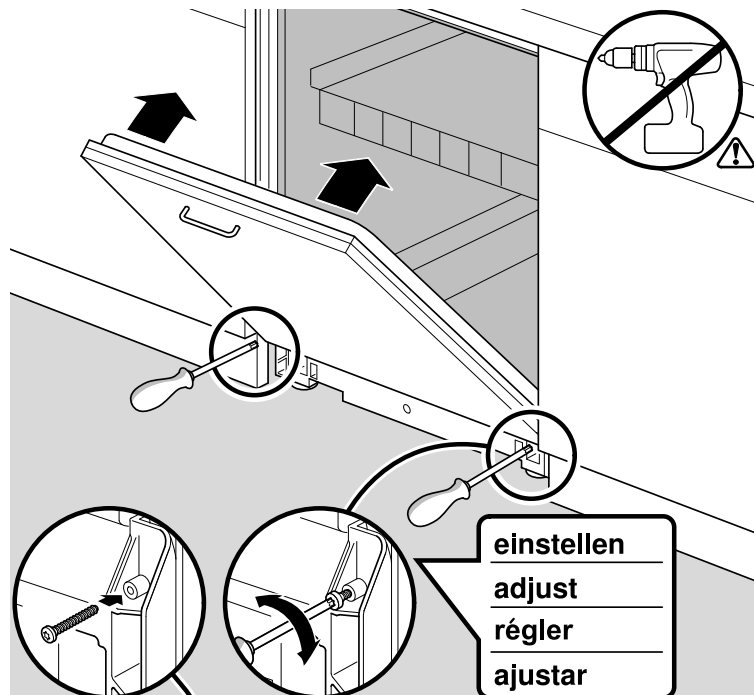
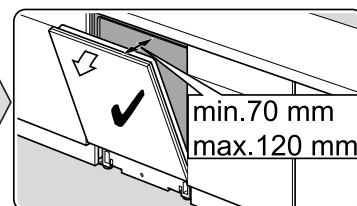
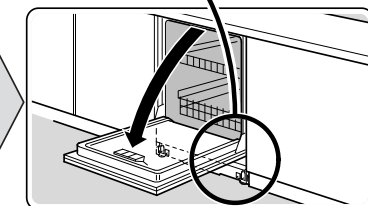
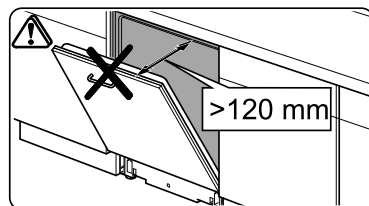
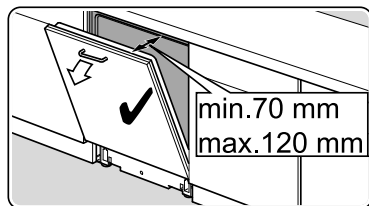

Ø4X36

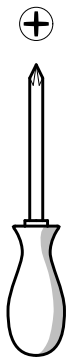
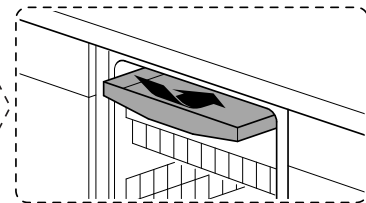
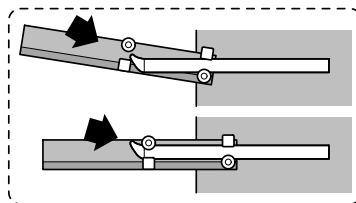
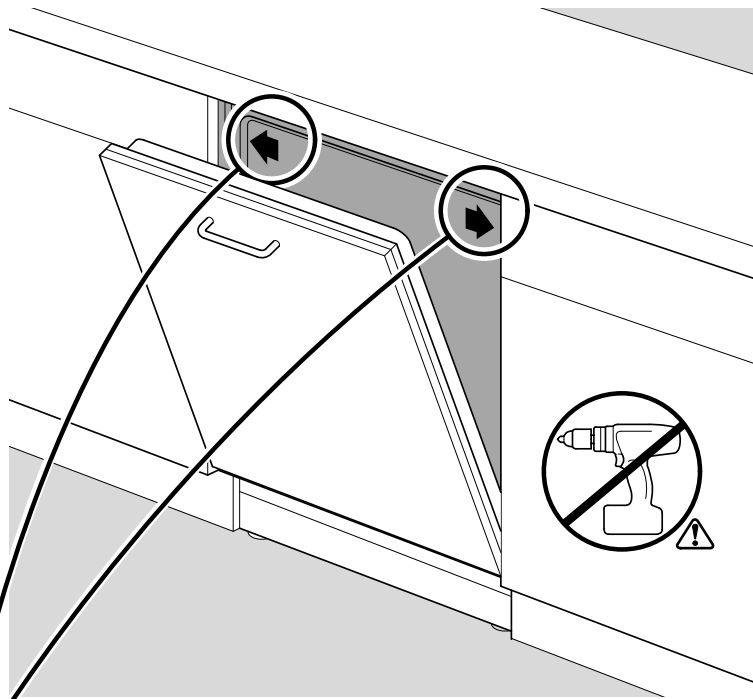
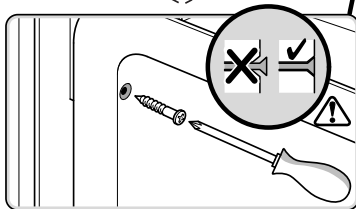
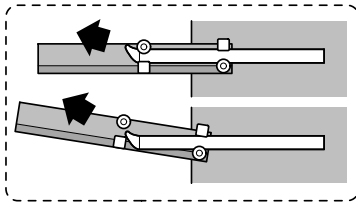
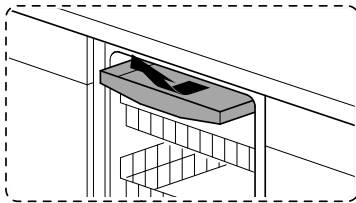
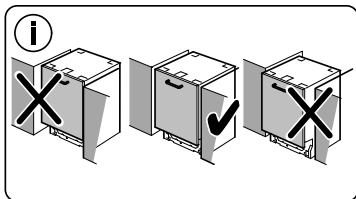
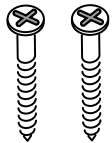

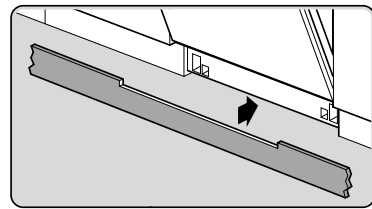
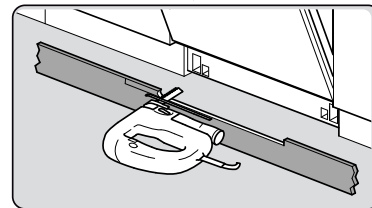
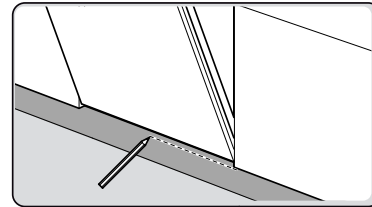
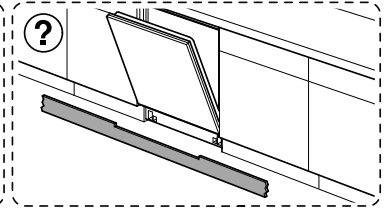
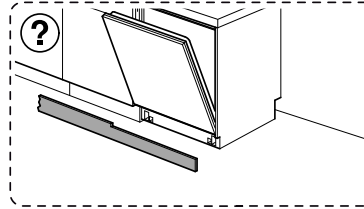
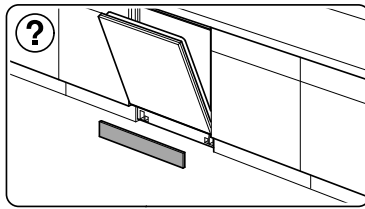
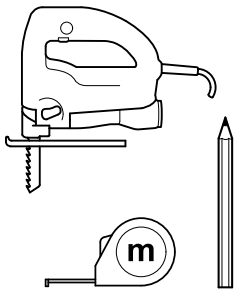

Ø4X15

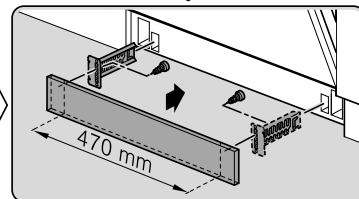
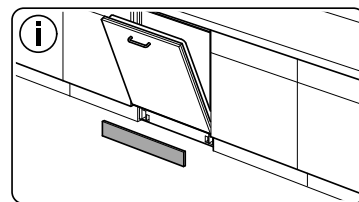
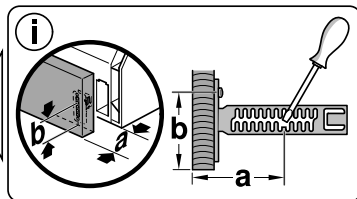
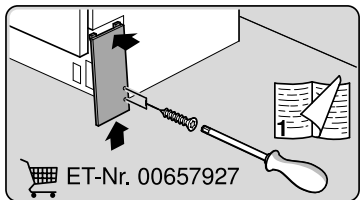
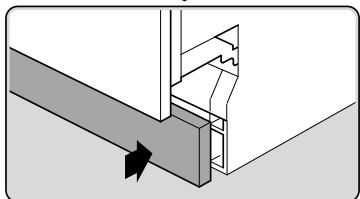
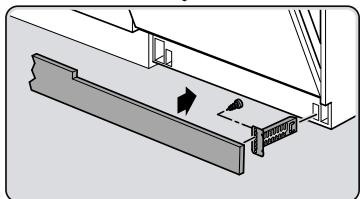
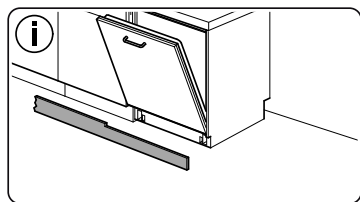
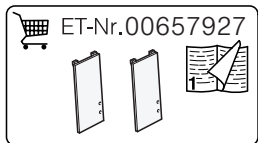
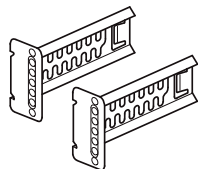

Torx  
T 20

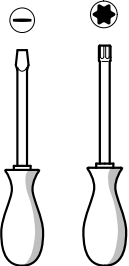

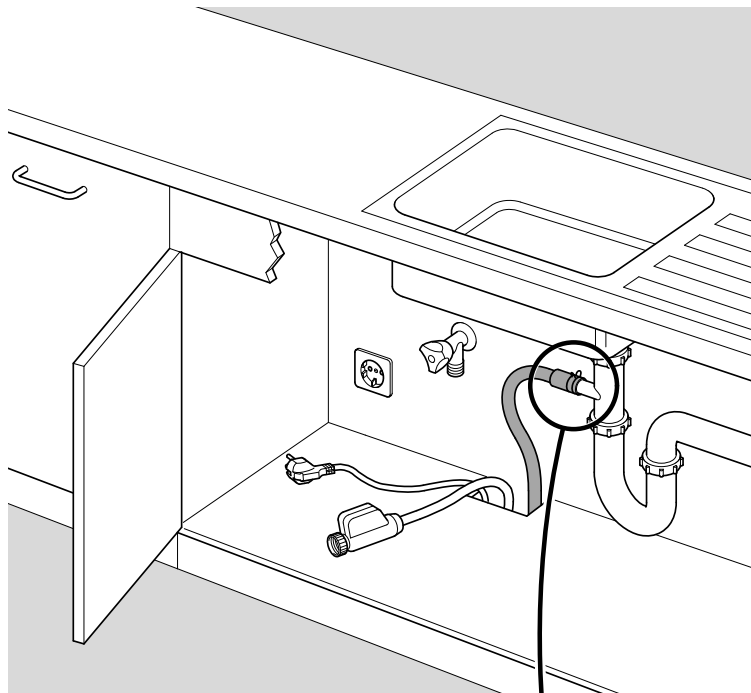
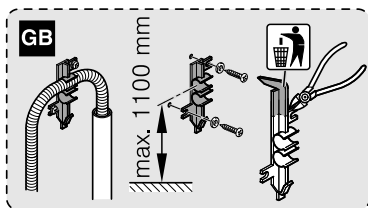
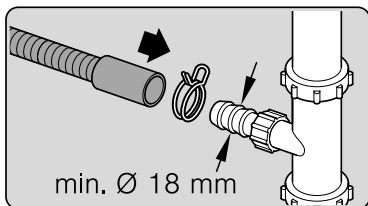
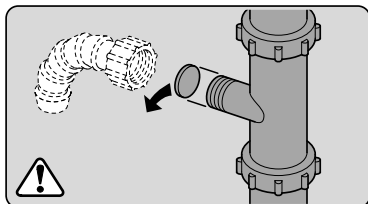
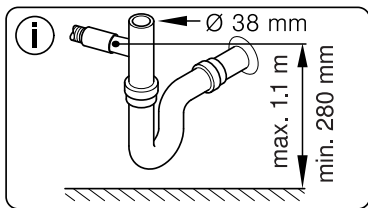
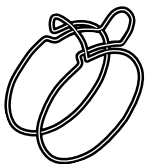

Dichtheit prüfen  
Check for leaks  
Verifiez l'étanchéité  
Verificar la estanqueidad

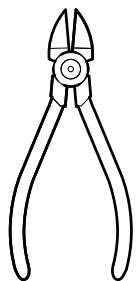
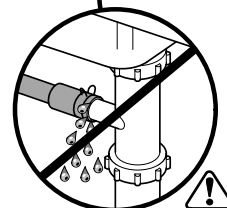

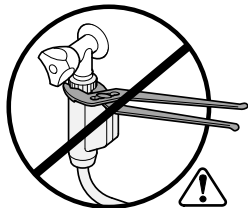
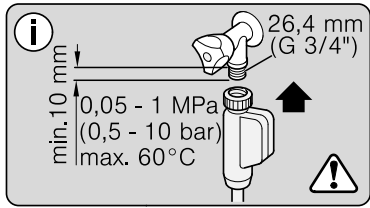

**max. 10 Nm**

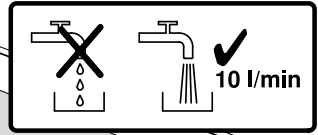
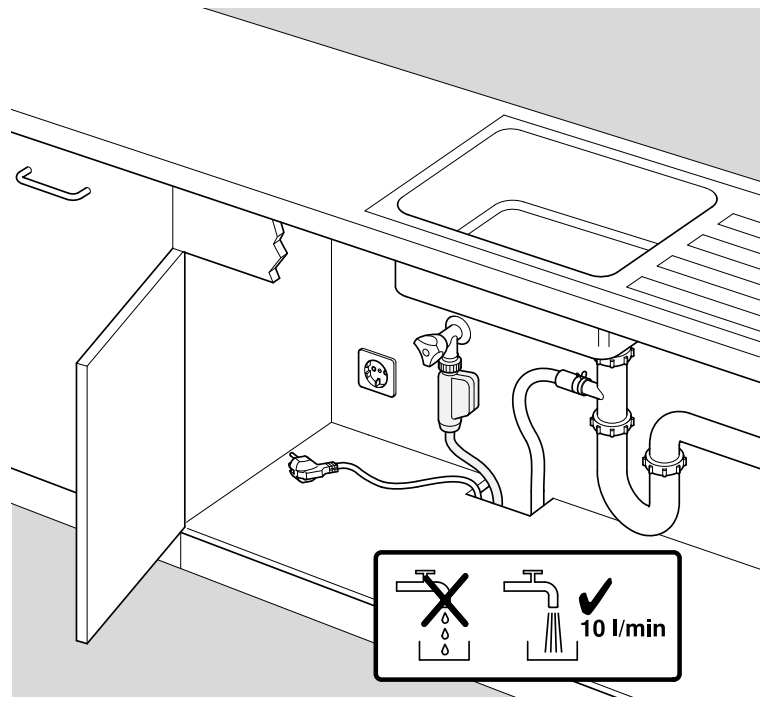

**Dichtheit prüfen**  
**Check for leaks**  
**Verifiez l'étanchéité**  
**Verificar la estanqueidad**



